

IVECO

Drive the road of change



Perfect crossing.

IVECO  -WAY



Drive the new way.

The IVECO X-WAY has been specifically designed for construction logistics and urban missions, and offers the perfect combination of IVECO's best long-haul technologies and legendary off-road robustness.

The IVECO X-WAY offers ultimate flexibility in tailoring the vehicle to your specific requirements. With its modular approach and mission-oriented design, HI-TRACTION system and off-road features, it guarantees high productivity in every mission all the way to the 'last mile' on jobsites.

The IVECO X-WAY raises the stakes in light off-road missions with the best payload capacity of the Super Loader mixer version, which has the lowest kerb weight in the industry.

The IVECO X-WAY integrates the most advanced features of the IVECO WAY range for long-haul on-road missions. The redesigned cab takes safety, comfort and fuel efficiency to an entirely new level. The highly fuel-efficient advanced engine technologies and low maintenance costs result in exceptionally low TCO.

The IVECO X-WAY makes the driver's life on board easier, more productive and safer with the unique IVECO DRIVER PAL vocal companion, which will transform the way you interact with your vehicle, and the wide portfolio of IVECO ON digital services.





IVECO

IVECO X-WAY



06	IVECO X-WAY at a glance	30	Gully cleaner
08	Tailor-made for your mission	32	The natural way
13	Premium driving comfort	34	Choose your configuration
14	The ultimate living and working environment	38	IVECO ON
16	Mission-oriented approach	42	ELEMENTS
18	Mixer	44	New IVECO DRIVER PAL
20	Tipper	46	Meet IVECO DRIVER PAL your vocal companion
22	Hook lifter & skip loader	48	IVECO Accessories
24	Crane & platform	49	IVECO Services
26	Tipper semi trailer	50	Choose your preferred IVECO X-WAY model
28	Timber		

IVECO X-WAY

at a glance.

Every single detail has been carefully studied to maximise your productivity. The modular, mission-oriented design approach enables you to tailor your vehicle to precisely match your specific requirements.



- 1** WIDE CHOICE OF ENGINES AND CABS
- 2** WIDE OFFERING OF GEARBOXES
- 3** CHASSIS WITH 7.7 MM-THICK SIDE MEMBER
- 4** MODULAR CONFIGURATIONS OF AXLES AND SUSPENSION
- 5** CONSTANT REAR FRAME SECTION
- 6** OPTIMISED MIRROR DESIGN
- 7** NEW A-PILLAR COVER FOR BETTER DRIVER VISIBILITY AND SAFETY
- 8** COMPLETE PTO OFFERING
- 9** NEW IVECO DRIVER PAL
- 10** VEHICLE SETUPS: ON, ON+, OFF
- 11** MULTI-PIECE BUMPERS
- 12** FULL LED HEADLIGHTS AND PROTECTION GRID
- 13** SUPER LOADER VERSION: BEST-IN-CLASS PAYLOAD
- 14** FRONT GRILL DESIGNS



Tailor-made for your mission.

Customize your bumper.

The all-new bumper offers a choice of plastic, hybrid or steel solutions, so you can choose the one that matches the requirements of your specific mission. The multi-piece bumper will protect you and your vehicle – and save on repair costs, as you only need to replace the damaged section.

You can also customize your bumper and side skirts with a choice of colour and material combinations. Rubber extensions on the side skirts contribute to the excellent aerodynamics and efficiency of the design.



The perfect choice of setups.

You can choose the setup that best matches your mission's requirements:



1 ON SETUP

Perfect for predominantly on-road missions

- On-road homologation (N3)
- Optimal comfort on the road and reinforced chassis
- Easy cab access and excellent visibility for the safest working conditions – also in urban situations

2 ON+ SETUP

Perfect for missions on different terrains, ensuring last-mile mobility

- On-road homologation (N3)
- Higher approach angle and ground clearance than ON setup
- Improved bumper protection

3 OFF SETUP

Perfect for predominantly off-road missions

- Off-road homologation (N3G)
- Off-road gradeability and approach angle (> 25°) for the best performance on the off-road sections of your mission
- Lower maintenance and repair costs than pure off-road vehicles

Last-mile mobility.

The IVECO X-WAY can rely on a vast range of features and functionalities that enable the vehicle to complete every type of mission, ensuring consistently high productivity all the way to the last mile.



HI-TRONIX gearbox with off-road functionalities

With the 12- and 16-speed HI-TRONIX automated gearbox you can benefit from a host of functionalities such as Rocking mode, Off-road mode, Creeping mode and 4 reverse gears to tackle with ease the off-road sections of your mission.

Fully modular axles and suspension concept

The IVECO X-WAY offers ultimate flexibility with a choice of rear axles in single and Hub Reduction, air and mechanical suspension and disk brakes front and rear.

HI-TRACTION hydrostatic drive

The HI-TRACTION system will switch to all-wheel drive to give you maximum grip – only when you need it – improving manoeuvrability and driving safety, while increasing fuel efficiency.

STEERING WHEEL

All the vehicle's key functions at your fingertips

INTEGRATED HVAC SYSTEM

Heating, ventilation and air conditioning with "Eco mode" function

KEY LOCK AREA

Turn the engine on and off by simply pushing the Start/Stop button



**TWILIGHT
& RAIN SENSOR**

Automatically turns
on the headlights
and windscreen wipers

INFOTAINMENT

Bring your digital life on board
with smartphone mirroring
and innovative features



Internal AD cab

Premium driving comfort.

The entire driver area has been created to provide the ultimate driving environment with outstanding ergonomics and controls layout, more space and excellent visibility. Every single detail has been carefully studied to meet the driver's expectations on the road.



Customize your seats with leather or fabric upholstery
and enjoy the luxurious comfort of the cushions



Choose the soft touch or leather steering wheel, both available
in the classic shape or with the distinctive flat base

The ultimate living and working environment.



Dashboard AS cab



1



2



3



4



5

The cab has been designed around the driver to provide superior quality of life on board. The new cab design creates a spacious, well-appointed living environment, while the night area combines functionality and comfort with its new symmetrical layout and well-placed storage, USB connections and controls.

- 1 Two USB ports are located on the upper pockets of each wall
- 2 Wide selection of refrigerators with capacities up to 100 litres and available with freezer
- 3 The lower console can contain a thick A4 folder
- 4 The new open glove compartment includes a 1.5-litre bottle holder
- 5 The symmetrical layout of the night area has been redesigned with the one-piece lower bunk – available with a choice of soft or hard mattress. You can also choose from the Smart or Comfort upper bunk, which can be used as a luggage compartment or a passenger bed

Mission-oriented approach.

The IVECO X-WAY was created with a **mission-oriented approach**, to enable you to tailor your vehicle's configuration to match your requirements precisely. Its **wide choice of features and components**, the legendary robustness of its chassis, every detail of its design result in a vehicle that can be configured for an **extensive variety of missions** – which it will perform flawlessly.





Mixer.

The IVECO X-WAY pushes the boundaries when it comes to its exceptionally low kerb weight. the SL version has the best payload capacity in the industry with an 8x4 chassis set up for a concrete mixer, featuring a 9-litre engine with up to 400 hp (294 kW) and 1700 Nm, it is the best in its category for power and torque density, and delivers outstanding fuel efficiency.

1 ALLOY WHEELS

Aluminum wheels are available, enabling you to reduce kerb weight by up to 165 kg, depending on the number of axles

2 REAR AXLE

Opt for Single Reduction, which gives you the best fuel consumption solution, or Hub Reduction if you need higher ground clearance without affecting kerb weight, which remains exceptionally low with our Tandem Light HR with disk brakes (HR-TL available with Super Loader versions, HR-TM for the 11-litre engine)

3 FRONT AND REAR DISC BRAKES

Disc brakes ensure better deceleration and involve lower maintenance costs and wear and tear

4 EXCELLENT MANOEUVRABILITY

The offering of axle configurations and wheelbases delivers excellent manoeuvrability and turning circle

5 ROBUST CHASSIS

The legendary strength of the chassis, with its 7.7 mm frame with constant section, easily deals with the exceptional demands made by the fully loaded, rotating drum. The 6.7 mm frame enables you to reduce your kerb weight by up to 40 kg

6 MECHANICAL OR AUTOMATED GEARBOX

The automated gearbox provides greater driving comfort and achieves its best performance when working with the High Mobility functions: Rocking mode, for the most difficult grounds; Creeping mode, for precise maneuvering operations at low speed



7 EXHAUST SYSTEM

Horizontal exhaust for missions requiring lower kerb weight and vertical exhaust for a healthy environment

8 IMPROVED DIRECT AND INDIRECT VISIBILITY

The aerodynamic design of the mirrors and their optimized positioning further improves visibility. The rear window of the AD/AT cabs provides excellent visibility on the rear of the vehicle

9 IDEAL POWER TAKE-OFF

The IVECO X-WAY offers a choice of permanently engaged PTOs, switchable/not switchable with Flange or Pump output PTOs, as well as the new sandwich PTO that deliver up to a maximum of 2450 Nm, which is perfect for a mixer body combined with a concrete pump

10 ENGINES

The 9-litre and 11-litre engines deliver all the power you need with outstanding fuel efficiency. Choosing the SUPER LOADER with the 9-litre engine, your kerb weight is reduced by up to 350 kg compared to the same with the 11-litre engine

11 SUSPENSIONS

Front axle load up to 9 tonnes. The 2-leaf front & 3-leaf rear mechanical suspension is the standard content, but you can customize your vehicle with every combination possible - also choosing from the available 1 leaf front parabolic suspension and 2 leaf rear parabolic and pneumatic suspensions - to cover all your mission needs, reducing kerb weight by up to 60 kg

12 THE RIGHT CAB

The ideal cab for mixer trucks is the AD short cab with low roof: it is lighter, so you can carry a bigger payload



Tipper.

The IVECO X-WAY tipper will drive everywhere you need to go: on- and off-road, up and down steep slopes, on uneven winding tracks and barely marked paths across open land. It will reliably complete every transport job to your – and your customers' – full satisfaction. The choice of features and setups enables you to specify exactly the right tipper for your business.

1 TIPPER EQUIPMENT

Pneumatic provision for the tipping control mounting from the frame to the driver's seat is available. Optional inspection step on the mudguard and safety handles on the roof can be specified

2 PAYLOAD

The chassis is designed to carry the biggest payload in the sector. Features such as the pneumatic suspensions, aluminium rims and air and fuel tanks further reduce kerb weight allowing for a bigger payload

3 WIDE OFFER OF CHASSIS

Choose from a wide offering of wheelbases, ranging from 3120 mm to 6700 mm, and rear overhang lengths

4 MULTIPLE AXLE CONFIGURATIONS

The offering of 2, 3 or 4 axles with different axle types allows you to choose from a wide variety of configurations to match your exact needs: 4x2, 6x4 and 8x4, also in Tridem version

5 REAR AXLES

Opt for Single Reduction, which gives you the best weight and fuel consumption solution, or Hub Reduction if you need higher ground clearance

6 REAR SUSPENSIONS

The IVECO X-WAY offers a choice of leaf or air suspension in combination with all configurations. Air suspensions maximise comfort and enable you to lower the loading height of the vehicle

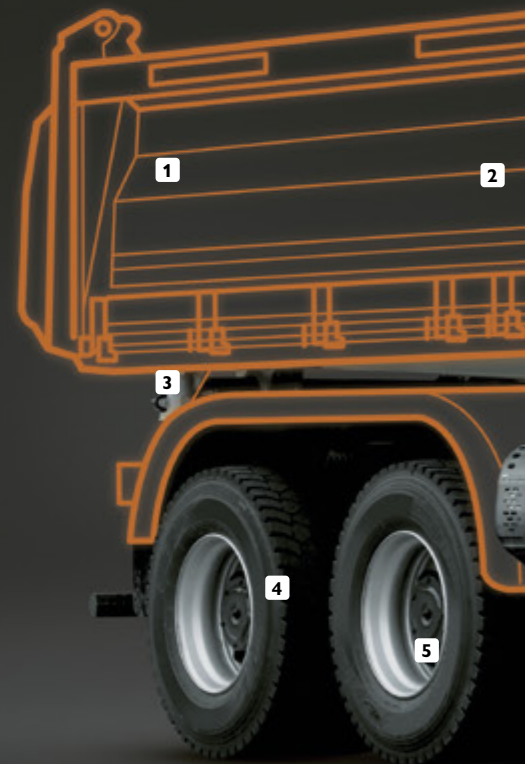

7 POWER TAKE-OFF

The body lifting hydraulic circuit is driven by a gearbox PTO, which can be fitted in different positions, or engine PTO switchable/not switchable - available with Flange or Pump output, that delivers the power needed to operate all types of rear tipper

8 CHOICE OF GEARBOXES

Manual, automated or automatic: choose your transmission according to the type of road use – maximise comfort and safety while reducing operating costs. Also High Mobility functions are also available: Rocking mode, for the most difficult grounds; Creeping mode, for precise maneuvering operations at low speed; Off-road mode, when higher rpms are needed before shifting to faster gears

9 FRONT AND REAR DISC BRAKES

Disc brakes ensure better deceleration and involve lower maintenance costs and wear and tear

10 IMPROVED DIRECT AND INDIRECT VISIBILITY

The aerodynamic design of the mirrors and their optimized positioning further improves visibility. The rear window of the AD/AT cabs provides excellent visibility on the rear of the vehicle

11 CAB

A comfortable and safe cab to match every preference: AD short cab, AT sleeper cab or AS wide sleeper cab

12 ENGINES

The line-up offers a choice of engines with three displacements – 9, 11 and 13 litres – to deliver the right power and torque for your mission

13 COMFORTABLE AND SAFE ACCESS

Well placed handles and footsteps provide safe access to the cab and tipping bridge. The dropdown lowest step is hung with rubber straps to better absorb shocks

14 FRONT AXLE

Leaf spring up to 9 tonnes

15 VEHICLE SETUPS

Choose the vehicle setup that matches your specific requirements: ON, ON+ with on-road homologation, or OFF certified for off-road



Hook lifter & skip loader.

The IVECO X-WAY offers the **outstanding manoeuvrability, compact overall dimensions, ground clearance and traction** you need in your hook lifter and skip loader. The extensive range of configurations provides the **extreme flexibility to match your mission precisely**: distribution with many loading and unloading cycles every day; long distance transport with a couple of cycles a day; urban missions requiring **excellent manoeuvrability or driving on difficult terrain**.



1 REAR LED LIGHTS

2 THE RIGHT CHASSIS

Constant chassis frame section and wheelbases ranging from 3120 mm to 6700 mm to fit all container sizes

3 REAR AIR SUSPENSIONS

The air suspension enables you to lower the rear of the vehicle when loading and unloading the container

4 PAYLOAD IS A KEY FACTOR

The components in the chassis area maximise the possible payload

5 VERTICAL EXHAUST SYSTEM

6 GEARBOX

Manual, automated or automatic: choose your transmission according to the type of road use – maximise comfort and safety while reducing operating costs

7 ENGINES

Engines that deliver the power you need: the 9-litre engine or the boost-optimised 11-litre

8 HYDROSTATIC DRIVE

All the traction you need and a bigger payload with HI-TRACTION. It is lighter than all-wheel-drive and gives you all the grip you need before and after loading and unloading. It is also available with the new Creep working function that completely disconnects the driveline, enabling you to move the vehicle with hydrostatic power only

9 HIGH MANOEUVRABILITY

The rear added steering axle optimises the steering circle for outstanding manoeuvrability on 8x2 versions. Tridem versions for 8x4 configurations further reduce the turning circle

10 REAR AXLES

Opt for Single Reduction if your hook lifter or skip loader works mainly on tarmacked roads, or Hub Reduction if it drives on more challenging surfaces

11 FRONT AND REAR DISC BRAKES

Better deceleration with lower maintenance costs and less wear and tear

12 WIDE CHOICE OF PTO

The IVECO X-WAY offers a wide choice:

- engine PTOs, switchable/non-switchable with Flange or Pump output PTOs;
- gearbox PTOs, which can be fitted in several position with Flange or Pump output PTOs;
- sandwich PTOs that deliver up to a maximum of 2450 Nm

13 VEHICLE SETUPS

The choice of three setups (ON, ON+, OFF) offers you the best trade-off between ground clearance and comfort

14 IMPROVED DIRECT AND INDIRECT VISIBILITY

The aerodynamic design of the mirrors and their optimized positioning further improves visibility. The rear window of the AD/AT cabs provides excellent visibility on the rear of the vehicle

15 CAB

The best cab for your needs: AD short cab; AT sleeper cab with low or medium roof; or AS sleeper cab with high or low roof



Crane & platform.

The IVECO X-WAY can be fitted with **every type of crane**, from flatbed to platform cranes. The **robustness and modular** concept of the vehicle enables us to fit cranes at the back of the cab, in a central position or at the rear of vehicle with no **compromise on stability**.

1 REAR SUSPENSIONS

The air suspension provides better stability for the vehicle when the crane is working

2 REAR AXLES

Opt for Single Reduction if your crane works mainly on tarmacked roads, or Hub Reduction if it drives on more challenging surfaces

3 ROBUST CHASSIS

The legendary strength of the chassis, with its 7.7 mm frame with constant section, easily deals with the exceptional demands made by the concentrated load of the crane setup

4 LAYOUT: FILTER AND TANKS

The IVECO X-WAY offers multiple choice of Air Filters and Fuel Tanks options, which can be mounted into different positions: filter behind cab or onto the chassis, fuel tanks in standard or low profile versions onto the LH side, RH side or both. This allows to obtain free space for your body application wherever needed

5 POWER TAKE-OFF

The hydraulic circuit operating the crane is driven by a gearbox or engine PTO. A choice of PTOs is available: Engine side: switchable/non-switchable with Flange or Pump output PTOs; Gearbox side: top/bottom/central/right positioned PTOs with flange or Pump output

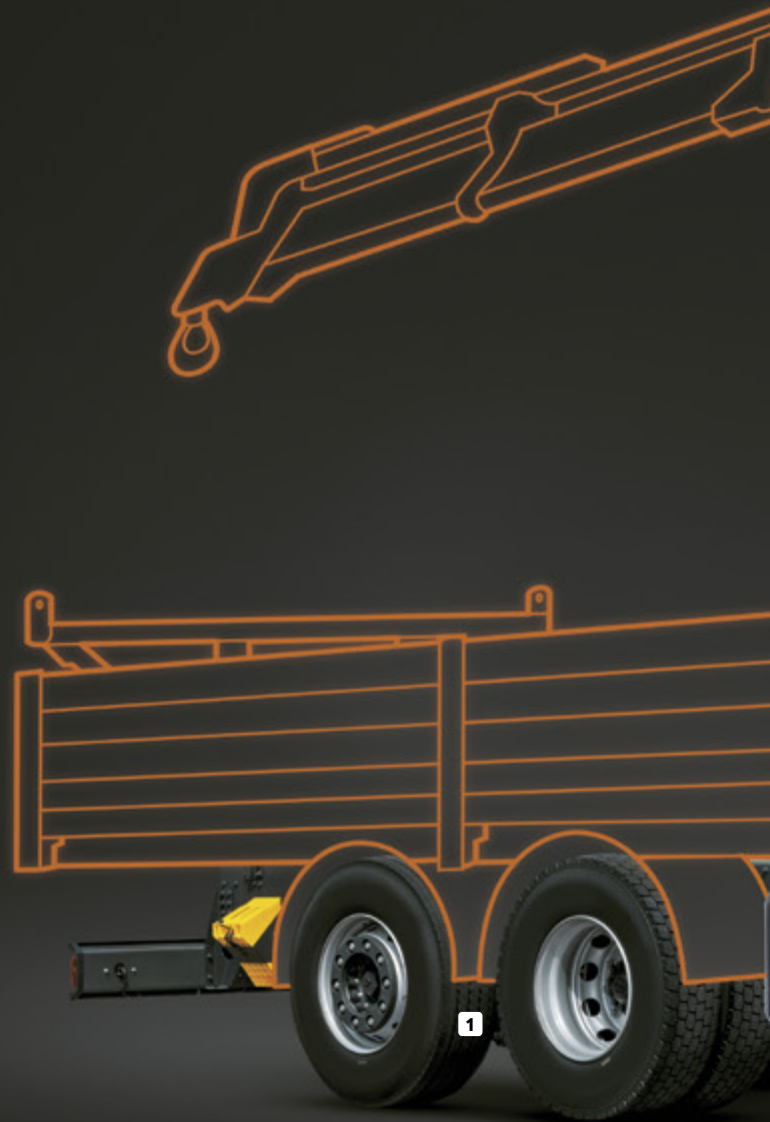

6 EXHAUST SYSTEM

A vertical exhaust system is available for cleaner air around the truck

7 360° VIEW

The excellent field of view provides excellent visibility around the vehicle

8 HYDROSTATIC DRIVE

Get all the traction you need and carry a bigger payload with HI-TRACTION. It is lighter than all-wheel-drive and gives you all the grip you need on dirt roads – also after the vehicle has been unloaded. It is also available with the new Creep working function that completely disconnects the driveline, enabling you to move the vehicle with hydrostatic power only

9 GEARBOX

Manual, automated or automatic: choose your transmission to maximise comfort and safety while reducing operating costs

10 ENGINES

The line-up offers a choice of engines with three displacements – 9, 11 and 13 litres

11 THE RIGHT CAB

You can choose from the AD short cab, or the AT and AS sleeper cabs, all available with low roof

12 FRONT AND REAR DISC BRAKES

Better deceleration with lower maintenance costs and less wear and tear



Tipper semi trailer.

IVECO X-WAY tractors combine the best fuel efficiency and safety technologies with the ultimate comfort of the AS cab. These features give you the confidence to tackle with ease the “last-mile” and the difficult conditions of jobsites when making your delivery, while ensuring high productivity, safety and excellent Total Cost of Ownership.



1 SAFETY

On-road safety: EBS, ESP, AEBS and LDWS

2 FRONT AND REAR DISC BRAKES

Disc brakes ensure better deceleration and involve lower maintenance costs and wear and tear

3 FUEL-EFFICIENT ENGINES

The 11- and 13-litre engines, combined with the IVECO X-WAY's fuel efficiency features, such as Ecoroll, Smart auxiliaries or the Eco mode functions, deliver outstanding fuel savings

4 EFFICIENT GEARBOXES

Choose from manual, automated and automatic transmissions, and drive down fuel consumption with OverDrive ratio. The fuel efficient HI-TRONIX calibration is also available

5 HYDROSTATIC DRIVE

The HI-TRACTION hydrostatic front-wheel drive is lighter than all-wheel-drive and delivers all the traction you need, making the IVECO X-WAY perfect even in light-duty construction site use. It is also available with the new Creep working function that completely disconnects the driveline, enabling you to move the vehicle with hydrostatic power only

6 COMFORTABLE CAB

Comfortable and safe cab to match every preference: AD short cab, AT sleeper cab or AS wide sleeper cab

7 ENGINE POWER TAKE-OFF

The engine-driven PTO enables you to partially tilt the tipper semi-trailer when the vehicle is stopped on a downhill slope to balance the load

8 ROBUST CHASSIS

Legendary strength of the chassis, with 7.7 mm frame and constant section

9 FIFTH WHEEL

Wide offering of fifth wheels with different heights and positions, including slider fifth wheel

10 REAR AIR SUSPENSION

Choose the air suspension to maximise driving comfort if your missions involve extensive road use

11 REAR AXLES

Opt for Single Reduction if your tractor works mainly on tarmacked roads, or Hub Reduction if it drives on more challenging surfaces

12 MULTIPLE AXLE CONFIGURATIONS

4x2 and 6x4 configurations are available to match your precise needs



Timber.

The IVECO X-WAY delivers the high power you need and offers the ideal features to load, transport and unload timber with ease. It will transport your logs comfortably in forests and woods, on the roads, and all the way to your destination: our powerful engines, 3 vehicle setups, the robust chassis, big payload capacity and hydrostatic drive are all features designed for this multi-faceted mission.



1 VERSATILE CAB

The IVECO X-WAY has a versatile and safe cab to match every need: AD short cab, AT sleeper cab or AS wide sleeper cab

2 VEHICLE SETUPS

The choice of three setups (ON, ON+, OFF) offers you the best trade-off between ground clearance and comfort according to the amount of on- and off-road driving required in your missions

3 POWERFUL ENGINE

The 9-, 11- and 13-litre engines are designed to match the highest torque-to-power ratio and deliver outstanding fuel efficiency

4 HYDROSTATIC DRIVE

Carry a bigger payload on difficult terrains and save fuel with HI-TRACTION: lighter than all-wheel-drive, it delivers all the traction you need, when you need it, and on all types of surface. It is also available with the new Creep working function that completely disconnects the driveline, enabling you to move the vehicle with hydrostatic power only

5 FRONT AND REAR DISC BRAKES

6 STRONG REAR SUSPENSIONS

Leaf or air suspensions are available in combination with all configurations

7 PAYLOAD

The chassis is designed to carry the biggest payload in the sector

8 ROBUST CHASSIS

Legendary strength of the chassis, with 7.7 mm frame and constant section and wheelbases ranging from 3120 mm to 6700 mm to fit all sizes of logs

9 HIGH MANOEUVRABILITY

Excellent steering circle for outstanding manoeuvrability



Gully cleaner.

The IVECO X-WAY is optimised for easy installation of a gully cleaner body and to provide all the features you need. High performance is essential in this mission, and the new clutch independent sandwich PTO designed to unleash up to 2450 Nm delivers the huge torque required.

1 ROBUST CHASSIS

Legendary strength of the chassis, with 7.7 mm frame and constant section

2 REAR AXLES

Opt for Single Reduction if your vehicle works mainly on tarmacked roads, while Hub Reduction is ideal for "Stop & Go" missions

3 REAR AIR SUSPENSION

Choose the air suspension to maximise driving comfort if your missions involve extensive road use

4 HIGH MANOEUVRABILITY

The third steering axle optimises the steering circle for outstanding manoeuvrability. Tridem versions for the 8x2 and 8x4 further reduce the turning circle

5 BIG PAYLOAD

The components in the chassis area maximise the possible payload, a key factor for gully cleaners



6 POWERFUL PTO

The IVECO X-WAY offers a wide choice of PTOs:

- Between Engine and Gearbox: Multipower PTOs that deliver up to 900 Nm torque or the sandwich PTOs for huge torque of up to 2450 Nm.
- Engine side: switchable/non-switchable with Flange or Pump output PTOs;
- Gearbox side: top/bottom/central/right positioned PTOs with flange or Pump output

7 HYDROSTATIC DRIVE

Carry a bigger payload on difficult terrains and save fuel with HI-TRACTION: lighter than all-wheel-drive, it delivers all the traction you need wherever you need it. It is also available with the new Creep working function that completely disconnects the driveline, enabling you to move the vehicle with hydrostatic power only

8 GEARBOX

Manual, automated or automatic: choose your transmission to maximise comfort and safety while reducing operating costs

9 IMPROVED DIRECT AND INDIRECT VISIBILITY

The aerodynamic design of the mirrors and their optimized positioning further improves visibility. The rear window of the AD/AT cabs provides excellent visibility on the rear of the vehicle

10 EXHAUST SYSTEM

A vertical exhaust system is available for clean air around the vehicle

11 CAB

Short or long, narrow or wide, the IVECO X-WAY has the cab to match every preference

12 HIGH PERFORMANCE ENGINES

The 9-, 11- and 13-litre engines are designed to match the highest torque-to-power ratio and deliver high fuel efficiency

13 FRONT AXLE

Leaf spring up to 9 tonnes

14 FRONT AND REAR DISC BRAKES

Better deceleration with lower maintenance costs and less wear and tear



The natural way.

IVECO X-WAY natural gas is the light off-road vehicle powered by the most mature natural gas technology on the market. It gives you the competitive advantage with a truly 'green' and profitable solution for light off-road transport with best-in-class Total Cost of Ownership.

Efficient environmental sustainability.

The IVECO X-WAY natural gas maximises the advantages of the most environmentally-friendly fuel to improve air quality, mitigate climate change and contribute to a quieter environment with just 71dB(A) Piek Quiet Truck when running in Silent mode.





A combination for every mission

The tanks are available in CNG, LNG or C-LNG version and are tailor made to free up the space you need on the chassis for your mission with a fuel autonomy of up to 1600 km.



LNG – up to 1600 km



LNG – up to 1400 km



LNG – up to 1150 km



LNG – up to 800 km

Choose your configuration.

The modular, mission-oriented approach of the IVECO X-WAY with a wide choice of features and components, together with the structural strength and low kerb weight, provides ultimate flexibility in customizing the vehicle to the specific requirements of a wide variety of applications.

Cabins.

The IVECO X-WAY cab line-up offers a choice of cabs to match your mission: the **AS** sleeper cab, the **AT** sleeper cab with low or medium roof, and the **AD** short cab with low roof.

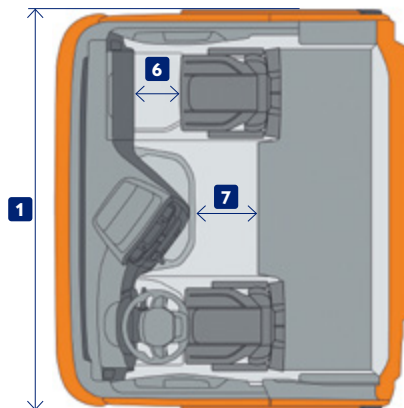
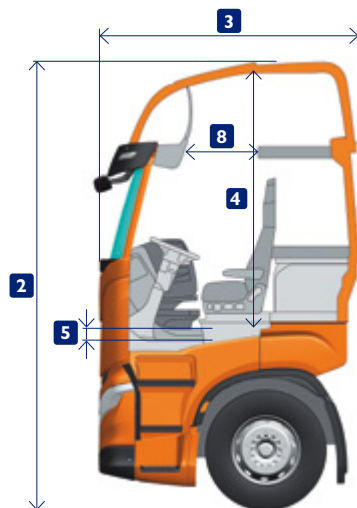

LEGEND

- 1** WIDTH
- 2** OVERALL HEIGHT
- 3** LENGTH
- 4** FLOOR TO ROOF CAB CENTRE
- 5** TUNNEL HEIGHT
- 6** PASSENGER USABLE SPACE
- 7** LOWER USABLE SPACE
- 8** UPPER USABLE SPACE

	1	2	3	4	5	6	7	8			
	Roof	Width (mm)	Overall height (mm)	Length (mm)	Floor to roof cab centre (mm)	Tunnel height (mm)	Passenger usable space (mm)	Lower usable space (mm)	Upper usable space (mm)	Bunk ⁽²⁾	Boarding Steps
AS	High	2500	3800 ⁽¹⁾	2250	2150	95	430	500	785	1 ⁽²⁾	3
	Low	2500	3300 ⁽¹⁾	2250	1700	95	430	500	–	1	3
AT	Medium	2300	3550 ⁽¹⁾	2150	1850	340	370	470	480	1 ⁽²⁾	3
	Low	2300	2900 ⁽¹⁾	2150	1250	340	370	470	–	1	3
AD	Low	2300	2900 ⁽¹⁾	1700	1250	340	370	–	–	0	3

Dimensions can vary according to the model

Note

⁽¹⁾ Approximate measures; may change based on suspensions, assembly variables and approximations

⁽²⁾ Upper bed as option

AS cab

Lower bunk length 2100 mm, width 800 mm (700 mm rear seats), upper bunk length 2040 mm, width 600 mm (700 mm with Comfort Bunk)

AT cab

Lower bunk length 1950 mm, width 540 mm, upper bunk length 1850 mm, width 680 mm

High-efficiency engines.

The IVECO X-WAY offers a wide choice of Euro VI diesel and natural gas engines to suit all applications. The diesel engines, with 3 displacements and power ratings ranging from 340 to 570, deliver class-leading power. The CI3 line-up, extended with the 490-hp and 530-hp engines, raises the bar on performance and fuel efficiency. The Cursor diesel engine EVI family is fully compatible with 2nd generation biofuels HVO / XTL (EN 15940). The CI3 engine is also available in natural gas version, which offers clean running and quiet operation.

DIESEL ENGINE LINE-UP

Engine	Displacement (Litres)	Power			Torque		Turbo	Cab type	
		hp	kW	rpm	Nm	rpm		AS	AT/AD
Cursor 9	8.7	340	251	1710 – 2200	1400	1100 – 1710	WG	–	•
		360	265	1530 – 2200	1650	1200 – 1530	WG	–	•
		400	294	1655 – 2200	1700	1200 – 1655	eVGT	–	•
Cursor 11	11.1	420	309	1475 – 1900	2000	870 – 1475	eVGT	•	•
		460	338	1500 – 1900	2150	925 – 1500	eVGT	•	•
		480	353	1465 – 1900	2300	970 – 1465	eVGT	–	•
Cursor 13	12.9	490	357	1700 – 1900	2400	950 – 1100	eVGT	•	–
		530	387	1600 – 1900	2400	950 – 1500	eVGT	•	–
		570	419	1605 – 1900	2500	1000 – 1605	eVGT	•	–

New horse power



Cursor 9



Cursor 11



Cursor 13

NATURAL GAS ENGINE LINE-UP

Engine	Displacement (Litres)	Power			Torque		Turbo	Cab type	
		hp	kW	rpm	Nm	rpm		AS	AT/AD
Cursor 13	12.9	460	338	1620 – 1900	2000	1100 – 1620	WG	•	–



Cursor 13 NP

FRONT BUMPERS

	Setup			AS cab				AD/AT cab			
	ON	ON+	OFF	Grey plastic parts		Cab coloured plastic parts		Grey plastic parts		Cab coloured plastic parts	
				•		•		•		•	
Bumper											
Hybrid	•	•	–								
Plastic	•	•	–								
Steel	–	–	•								

FRONT AXLES

	Rigid							Artic	
	4x2	6x2 Y/PS	6x2 Y/PT	6x4	8x2 (2+2)	8x4 (1+3)	8x4 (2+2)	4x2	6x4
Front axle load									
7500	•	•	•	•	•	•	•	•	•
8000	•	•	•	•	•	•	•	•	•
8500	–	–	–	•	–	•	•	–	•
9000	•	•	•	•	•	•	•	•	•
Setup ON					Setup ON+ / OFF				
Front axle drop									
142 mm					72 mm				

REAR AXLES

	Type	Max technical weight (ton)	Breaking type	Max breaking torque (kNm)	Oil type	Oil quantity (litres)	Service interval
SR							
MS17X-HE ⁽¹⁾	SR-Solo	13	Disc	18.2	Synthetic	11	Up to 400k km
MS13-17X ⁽²⁾	SR-Solo	13		18.2		12.5	
MT23-150/D	SR-TM	23		25		33.5	
HR							
451391/ADB	HR-Solo	13	Disc	25	Synthetic	16	Up to 400k km
452146/ADB	HR-TL	21				24.5	
452191/ADB	HR-TM	23 ⁽³⁾				38	

HI-TRACTION

	Rigid													Artic				
	4x2		6x2 Y/PS			6x2 Y/PT			6x4			8x2 / 8x4			4x2		6x4	
	C9	C11	C9	C11	C13	C9	C11	C13	C9	C11	C13	C9	C11	C13	C11	C13	C11	C13
Without HI-TRACTION	•	•	•	•	•	•	•	•	•	•	•	•	•	•	•	•	•	•
HI-TRACTION	–	•	–	•	•	–	–	–	–	•	•	–	–	–	•	•	•	•
HI-TRACTION + creep working	–	•	–	•	•	–	–	–	–	•	•	–	–	–	•	•	•	•

GEARBOX



Engine	Power (hp)	Torque (Nm)	Automated 16 speed		Automated 12 speed		Manual 16 speed		Automatic	
			ZF HI-TRONIX		ZF HI-TRONIX		ZF Ecosplit		Allison	
			SR axle	HR axle	SR axle	HR axle	SR axle	HR axle	SR axle	HR axle
			AS cab							
Cursor 13	570	2500	16TX 2640TD	16TX 2640TO	12TX 2640TO	12TX 2610TO				
	530	2400	16TX 2440TD	16TX 2440TO	12TX 2420TO	12TX 2410TO				
	490	2400			12TX 2210TD	12TX 2410TO				
			AS/AT/AD cab				AT/AD cab			
Cursor 11	480*	2300			12TX 2210TO	12TX 2410TO	16 S 2320TD	16 S 2520TO		
	460	2150				12TX 2210TO	16 S 2220TD			
	420	2000			12TX 2010TD	12TX 2010TO				
			AT/AD cab							
Cursor 9	400	1700			12TX 1810TD	12TX 1810TO				
	360	1650							3200-series	
	340	1400			12TX 1410TD				3200-series	

* Not available for AS cab

POWER TAKE OFF

	Dependent / independent From transmission	Connection	Ratio	Torque (Nm)	Rotation
Engine PTO					
Switchable	Independent	Pump / Flange	1.12 / 1.14	800	Opposite engine
Not switchable			1.14 / 1.195		
Sandwich PTO					
Switchable	Independent	Flange	1.02 / 1.26 / 1.56	1602 – 2450	Same as engine
Multipower PTO					
Switchable	Independent	Flange	1.29	900	Same as engine
Not switchable					
Gearbox PTO ⁽⁴⁻⁵⁾					
NH/1b – NH/1c	Dependent	Pump / Flange	1.00	1000	Opposite engine
NH/4b – NH/4c			0.90 / 1.28	430	Same as engine
NTX/10b – NTX/10c			0.91 / 1.09 / 1.28 / 1.58 / 1.59 / 2.35	400 – 720	
N221/10b – N221/10c			1.23 / 1.48 / 1.91 / 2.19	470 – 870	
NTX/10c+bR			(0.91–1.28) / (1.09–1.59) / (1.23–1.85) / (1.48–2.35)	400 – 720	
S3200 top mount		Pump	0.60	660	

● Standard ● Available – Unavailable

⁽¹⁾ For rear axle ratios ≤ 3.36 ⁽²⁾ For rear axle ratios ≥ 3.70 ⁽³⁾ 23 t for some countries only (0% overload admitted)

⁽⁴⁾ The total power take off ratio is a result of the PTO ratio and the speed factor of gearbox on the vehicle ⁽⁵⁾ Not switchable PTOs



is the new world of integrated services and transport solutions.

A clear benefit to our customers.

IVECO is "ON" your side, delivering real benefits for your business with the advantages of the service offer you chose:



To manage your fleet by monitoring your vehicles' fuel consumption and drivers, as well as planning their missions, optimising routes and dispatching orders



To keep your vehicle always on the road, anticipating and avoiding unforeseen breakdowns. Our roadside assistance will always be with you



Specific vehicle monitoring and reporting, and the assistance of your IVECO DRIVER PAL voice companion will leave you free to focus entirely on your work with no worries knowing that we will take care of you, your driver and your vehicles while on the road



For specialised assistance when you choose from our offer of tailored service contracts



To complete the IVECO ON offer by choosing original IVECO Parts and Accessories



Created by IVECO to help you make your business more competitive, profitable, sustainable and easier to manage

It provides a flexible offer that can be customised to match your business requirements and missions: from connected services to boost your vehicle's potential to a complete set of tailored aftermarket solutions to be at your side in every moment of your journey!

Discover the world of new services that come with the new IVECO WAY range!

Save money, improve your performance and simplify your work by choosing our connectivity and selecting the solution that is the best match to your requirements.

Find out more about the **commercial packages** you can choose your services from.





Smart Pack.

The Smart Pack, always included in all IVECO WAY range vehicles, offers the benefits of IVECO ON CARE and IVECO ON UPTIME provided with the following services.

Smart Report

The Driving Style Evaluation (DSE) algorithm generates weekly reports on the vehicle's and driver's performance with tips on how you can improve the driving style for fuel and vehicle optimisation.

Safe Driving Report

Together with the Smart Report and thanks to the Driving Style Evaluation, you will now receive this new report that will allow you to measure your safety on board.

IVECO ON customer portal and App

They enable you to monitor your vehicle's fuel consumption and your driver's driving style in a dynamic way, so you can identify how to optimise your fleet's performance. You can also plan and book service appointments efficiently to maximise uptime.

Vehicle monitoring and remote assistance

The remote diagnostics tool, the teleservices and the over-the-air software updates will grant you a proactive approach and maximised vehicle's uptime, anticipating possible faults and downtime.

The IVECO ON Easy Way App is designed to make your life easier

Manage the cabin and vehicle functionalities directly from your mobile device: driving style evaluation, remote assistance service and over the air update, cabin control all at hand. Now with IVECO DRIVER PAL integration to easily activate MYIVECO and MYCOMMUNITY Skills. Push notifications to keep you informed about the vehicle's health and a new QR code to pair your mobile device to your vehicle.



Cabin Control



IVECO Assistance Non-Stop



Driving Assist



Remote Assistance Service





Premium Pack.

The Premium Pack offers all the services included in the Smart Pack, plus the full benefits of IVECO ON CARE, UPTIME, FLEET and M&R. It guarantees follow-up on the data provided by your vehicle, by putting you in contact with IVECO experts who will advise you on the best way to use it. You can choose the modular options you wish to add to your package.

Professional fuel advising

IVECO TCO Advisor will provide you with periodic consultancy and advice on how to reduce fuel consumption, maximising your use of the truck.

Flexible maintenance*

The real-time data provided by your vehicle through its connectivity enables you to plan maintenance interventions efficiently, to reduce unplanned stops and maximise the life of the monitored components based on the real usage of the vehicle.

Fleet management

It helps you monitor your vehicles' fuel consumption and drivers, plan their daily activities, optimise routes and dispatch orders. Increase your fleet administration capabilities through insights on driver's workdays and geolocation.

IVECO web API

The Application Program Interface allows flexible data integration in your own systems and facilitates the management of IVECO-generated data together with that of other brands' vehicles in a single tool.

Professional Safe Driving Report

Based on the results you will receive with the Safe Driving Report, our TCO Advisor will contact you in order to advise you on how to be safer on the road.

* Available only for X-WAY Artic Diesel

ELEMENTS.

Pick the services that perfectly match your business.

The IVECO X-WAY offers an extensive range of services that can be tailored to your precise requirements to keep your vehicle running in top form and your business operating with a healthy bottom line.

The IVECO X-WAY introduces an entirely new level of customisation through connectivity. The real-time vehicle data it provides enables us to offer you **bespoke maintenance plans** based on the real use of your IVECO X-WAY– a perfect match to your business. Alternatively, our **ELEMENTS** range offers the extreme **flexibility** that enables you to choose the combination of Planned Maintenance and Extended Warranty services for your business, and further enrich your package with the Additional Coverage Elements.



MAINTENANCE



- Maintenance
- Lubrication
- Oil and fluid changes according to the maintenance and repair handbook

DRIVE LINE



- Engin
- Fuel injection
- Gearbox
- Propeller shaft and axle repairs

EXTRA DRIVE LINE



- Components not already covered by the drive line element e.g. Electrical System

WEAR



- Clutch
- Brake pads
- Brake discs
- Brake drums
- Brake linings for drum brakes





The major “elements” making up the offer (maintenance, drive line, extra drive line, wear) can be combined in order to create the contract that perfectly suits your business. The table below summarises all the possible combinations:

PLANNED MAINTENANCE CONTRACTS

	Maintenance	Drive line	Extra drive line	Wear
	•	•	•	•
	•	•	•	
	•	•		•
	•	•		
	•			•
	•			

EXTENDED WARRANTY

	Drive line	Extra drive line
	•	•
	•	

 Try the Flexible Maintenance in order to maximise your maintenance interval with us.

For inclusions / exclusions please refer to contractual documents relevant to your Market

IVECO 

IVECO
DRIVER
PAL 

just ask | 

New IVECO DRIVER PAL.

IVECO DRIVER PAL takes the driver's life on board to the next level, turning their vehicle into the perfect travel companion.

"Alexa, open MYIVECO"

"Alexa, ask MYIVECO where is my vehicle"

"Alexa, what's the weather today?"

"Alexa, ask MYIVECO which is the level of the fuel"

"Alexa, ask MYIVECO to look for a restaurant to stop"

"Alexa, ask MYCOMMUNITY what are my messages"



COMFORT

In their smart cab, with Alexa fully integrated into the vehicle, drivers can interact with their truck and operate all in-cab controls simply using their voice.

SAFETY

With their voice companion, drivers enjoy a safer driving experience with fewer distractions, taking care of secondary tasks using their voice so they can remain focused on the mission.

PRODUCTIVITY

With the new, innovative voice service, drivers can vocally manage their route planning, check their vehicle's health status, ask for help to avoid unplanned stops and delays with information about traffic jams, weather conditions and other disruptions.

COMMUNITY

With IVECO DRIVER PAL, drivers are connected with the driver community. They can safely communicate with other drivers, share information and advice on their route – and language is no barrier, because their IVECO vocal companion translates for them.

Meet IVECO DRIVER PAL

your vocal
companion.

IVECO ON

IVECO
DRIVER
PAL



With IVECO DRIVER PAL, drivers can bring their digital life on board, interact vocally with their vehicle and the driving community and access IVECO's connected services through Amazon Alexa voice commands. They can enjoy a better driving experience, keeping their hands on the steering wheel and their eyes on the road!*

New features for an even better experience

The enhanced "Open MYIVECO" vocal request helps the driver navigate the most frequently used commands and stays open for a natural and fast interaction.



You can use the skills throughout the day - while you drive, when you are resting in the cab, or when you are at home, through a Alexa-enabled device or the dedicated App.

"Alexa, ask MYIVECO
to switch on ambience lights"



"Alexa, ask MYIVECO
to set the heater to 20 °C"



* Activate the IVECO DRIVER PAL Skills directly from the IVECO ON Easy Way App, just follow the steps on the tutorial. It is easy!

IVECO has developed two unique skills, MYCOMMUNITY and MYIVECO, with Amazon Alexa features, in collaboration with Amazon Web Services Professional Services and Alexa Auto team to help you work more comfortably and safely.

Try the innovative IVECO Skills dedicated to the driver's life on board and at home.*

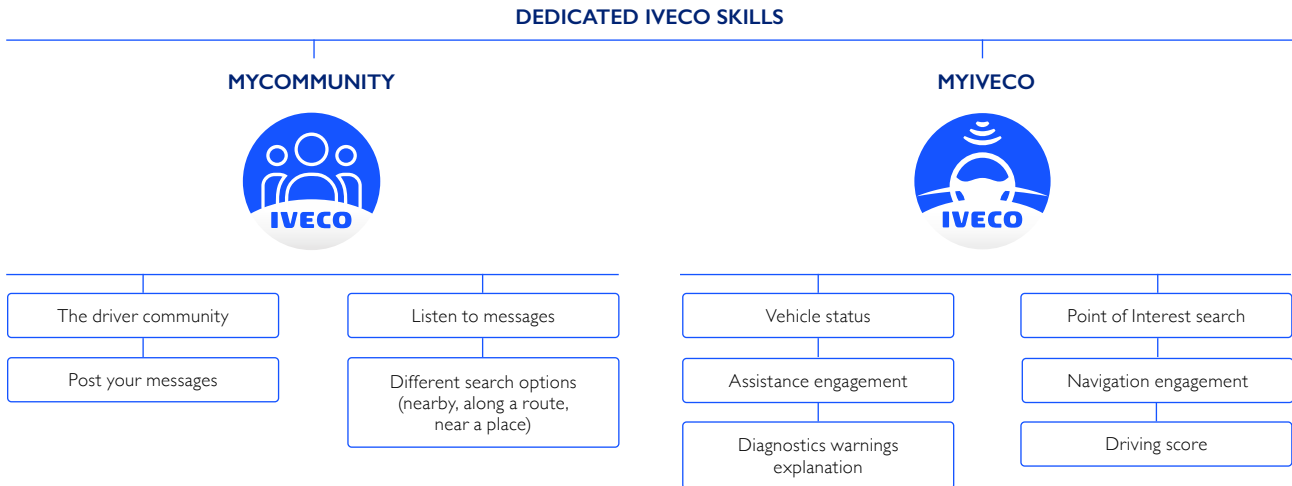

MYCOMMUNITY Skill.

Interact with the driver community

The exclusive MYCOMMUNITY Skill enables you to rely on the support of the driver community. You can exchange information on queues or traffic jams, tips on the best rest stops on your route – and language is no barrier, as messages are translated automatically.

MYCOMMUNITY App is free and available to all drivers.

MYIVECO Skill.

Enjoy the exclusive connected collaboration of IVECO DRIVER PAL

IVECO DRIVER PAL, coupled with the Connectivity Box, allows you to check battery charge, tyre pressure, fluids levels, as well as set a destination on the navigation system or book a service stop at the nearest IVECO workshop. You will enjoy a truly collaborative relationship with your vehicle!

* Amazon, Alexa and all related marks are trademarks of Amazon.com, Inc. or its affiliates

The truck is much more than a vehicle: it is where thousands of people live and work every day. That's why IVECO Accessories created a range of tailor-made products to meet the driver's needs, improve their performance, enhance the vehicle's style and comfort, and introduce new technologies on board.

Customize your IVECO X-WAY to the needs of your business.

Customize your IVECO X-WAY to match your missions choosing from a wide range of high quality accessories developed to enhance the visibility, comfort, safety and profitability of your vehicle. Details that make the difference.



1 VISIBILITY

The lightbar and bullbar are completely integrated in the cab to emphasise its shape and visibility. Full customisation with fleet sign to enhance the image of the Company is possible. Recommended for emergency situations or special manoeuvres, the beacon gives high visibility in all directions

3 SAFETY

Choose from a range of accessories to increase your safety when you drive, such as the high-quality reversing safety systems which provide a greater range of vision when performing manoeuvres

2 PROFITABILITY

IVECO Accessories offer you a wide range of anti-siphon, which can reduce your TCO. The aluminium devices prevent diesel fuel theft, are indestructible, allow a quick refueling and are easy to install

4 TECHNOLOGY ON BOARD

A new tailor-made dashboard bracket with integrated socket has been designed to recharge your smartphone, tablet, TomTom® and Drivelinc in the best and safest position

IVECO Genuine Parts represent the best guarantee of **safeguarding the value of IVECO X-WAY** over time, **protecting from unplanned downtime**, ensuring safety for people and goods. IVECO also offers the widest range of new and remanufactured components, servicing kits and telematics solutions, suitable for every stage of the IVECO X-WAY's lifecycle. IVECO operates a network of 6 parts depots across Europe, covering over 335,000 sqm, managing 400,000 part numbers and guaranteeing 24/7 parts delivery.



IVECO
0080048326000
Assistance Non-Stop



The **IVECO Assistance Non-Stop** answers 24 hours a day, 7 days a week, providing assistance in 36 European countries to help Customers keep their vehicles on the road. In case of breakdown it can be reached through a phone call, using the IVECO Non-Stop App, using the telematic system on board.

The **IVECO Non-Stop App** can also be used to book in advance a repair work for your vehicle, not just in case of urgency. You can select the time window and the location and the App will give you a confirmation of the booking.

IVECO CAPITAL







IVECO CAPITAL is the captive financial services Brand of IVECO, and offers a full range of financing, leasing, rental and ancillary services for commercial vehicles. Extended warranty, maintenance and repair services, and various types of insurance, can be included in the pack*. All financial packs can be tailored to the Customer's needs, and apply to new, used vehicles and conversions. For more information, please contact your IVECO Dealer.



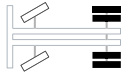
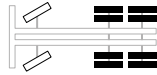

* Subject to credit approval. Offerings and products may vary by country depending on the local fiscal and accounting regulations

Choose your preferred IVECO X-WAY model.





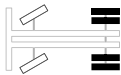





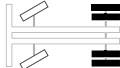

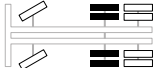
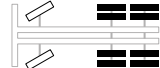
ARTIC DIESEL

		4x2		6x4	
IVECO X-WAY					
Cab roof	AS	-		-	
	AT		-		-
	AD		-		-
Engine / Gearbox	Cursor 9	-	-	-	-
	Cursor 11	Automated / Manual	Automated	Automated / Manual	-
	Cursor 13	-	Automated	-	Automated
Vehicle setup	ON	ON ON+ OFF	ON ON+	ON ON+ OFF	ON ON+
	ON+				
	OFF				
Rear axle suspension	SR	Mechanical / Pneumatic / Full Pneumatic		Mechanical / Pneumatic	
	HR				
Connectivity box		Standard for all models			
Wheelbases (mm)		3650 – 3800		3200 – 3300	







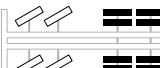

ARTIC NP

		4x2
IVECO X-WAY Natural Gas		
Cab roof	AS	
Engine / Gearbox	Cursor 13	Automated
Fuel system	CNG	Up to 650 km
	CLNG	Up to 1080 km
	LNG	Up to 1600 km
Vehicle setup	ON	ON ON+
	ON+	
Rear axle suspension	SR	Pneumatic / Full Pneumatic
Connectivity box		Standard for all models
Wheelbases (mm)		3800

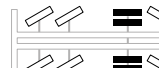
RIGID

		4x2	6x2P	6x2P (Twin)	6x4			
IVECO X-WAY								
Cab roof	AS	-	-		-			
	AT			-		-		
	AD			-		-		
Engine / Gearbox	Cursor 9	Automated / Allison	Automated / Allison	-	Automated	-	Automated / Allison	
	Cursor 11	Automated / Manual	Automated / Manual	Automated	Automated / Manual	Automated	Automated / Manual	
	Cursor 13	-	-	Automated	-	Automated	-	Automated
Vehicle setup	ON							
	ON+	ON ON+ OFF	ON ON+		ON		ON ON+ OFF	ON ON+
	OFF							
Rear axle suspension	SR	Mechanical / Pneumatic / Full Pneumatic	Pneumatic / Full Pneumatic		Pneumatic		Mechanical / Pneumatic	
	HR							
Wheelbases (mm)		3800 – 6700	3120 – 6050		3800 – 6050		3200 – 5100	

RIGID

		8x4 (2+2)	8x4 (1+3)	8x2x6 (2+2)			
IVECO X-WAY							
Cab roof	AS	-		-		-	
	AT		-		-		-
	AD		-		-		-
Engine / Gearbox	Cursor 9	Automated		Automated	-	Automated	-
	Cursor 11	Automated / Manual		Automated / Manual	-	Automated / Manual	-
	Cursor 13	-	Automated	-	Automated	-	Automated
Vehicle setup	ON						
	ON+	ON ON+ OFF	ON ON+	ON ON+ OFF	ON ON+		ON
	OFF						
Rear axle suspension	SR						
	HR	Mechanical / Pneumatic		Pneumatic		Pneumatic	
Wheelbases (mm)		4250 – 5820		3200 – 5100		4500 – 6050	

IVECO

Drive the road of change

PUBLICATION H2227901MASTER - 09/22

The information and images in this catalogue are provided as a guideline only. IVECO reserves the right to make changes for any commercial or construction reasons at any time without notice.